

## HR-600 SERIES

HIGH-END CNC ROCKWELL HARDNESS TESTING MACHINE

TEST EQUIPMENT  
AND SEISMOMETERS

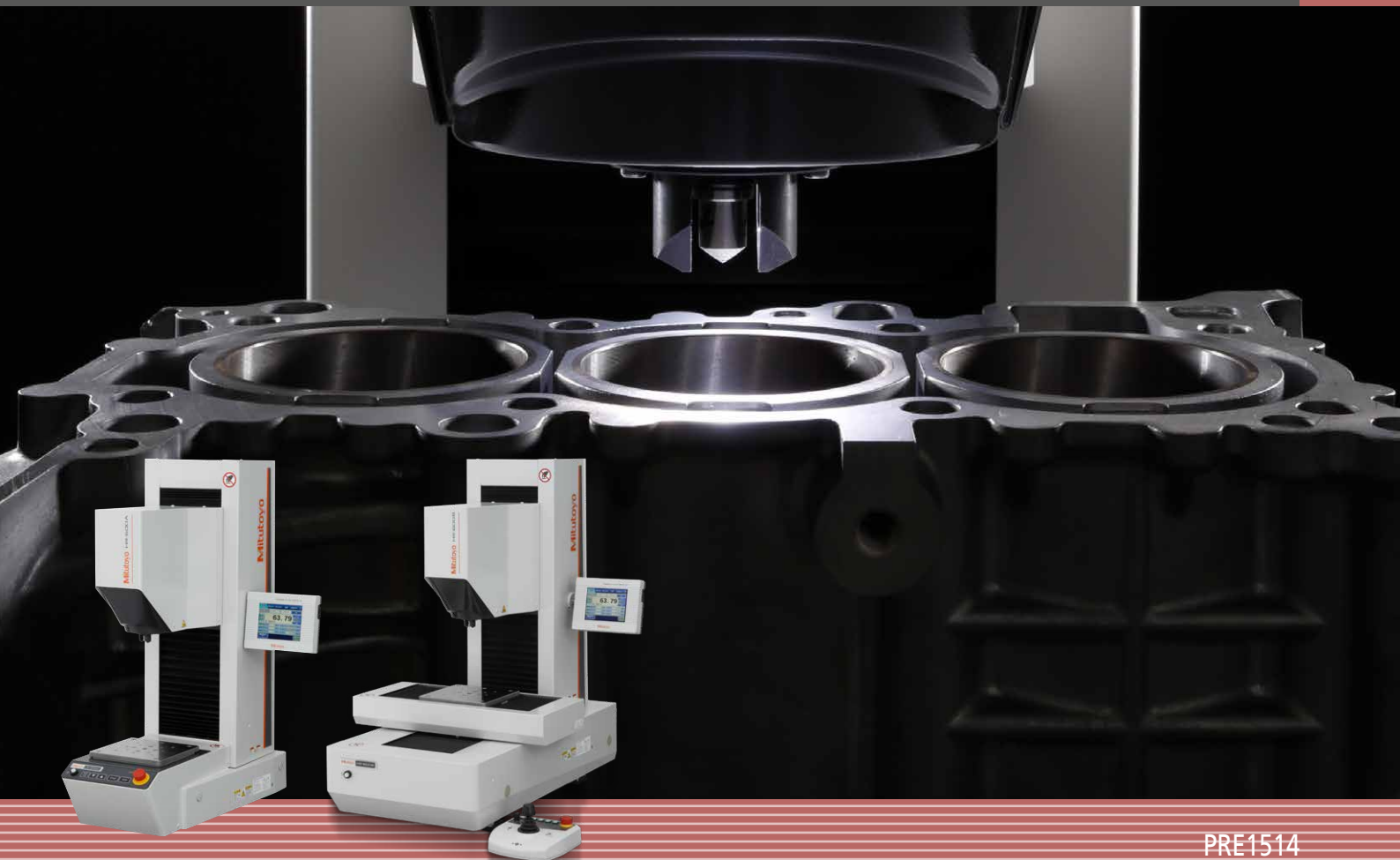

Go above and beyond.

# HR-600 SERIES

High-End CNC Rockwell Hardness Testing Machine

With innovative design and functionality that enables a wide variety of measurements, the HR-600 Series delivers hardness testing that defies conventional thinking.

The HR-600 Series combines the functionality of several previous models: Rockwell hardness testing, Brinell hardness testing, Brinell and Vickers depth measurement hardness testing and hardness testing of plastic materials. Supporting all test types in a single machine, this new series expands the range of available measurements.

With its high-resolution scale load cell developed uniquely by Mitutoyo that allows for high-precision test load feedback control and state-of-the-art design that delivers both aesthetics and usability on the ground, the new HR-600 Series enables hardness testing that defies conventional thinking.





# LINE-UP



**HR-610A**

Standard Rockwell hardness testing machine model with moving head

Maximum table loading 100 kg  
 Maximum workpiece height 250 mm  
 Depth (from indenter center) 220 mm  
 Test force 29.42 - 1839 N (3 - 187.5 kgf)



**HR-620A**

Rockwell hardness testing machine with high added value that can measure Brinell hardness and the hardness of plastics

Maximum table loading 100 kg  
 Maximum workpiece height 250 mm  
 Depth (from indenter center) 220 mm  
 Test force 9.807 - 2452 N (1 - 250 kgf)

**HR-620B**

Fully automatic multi-point Rockwell hardness testing machine with Y-axis stage mobility that can measure micro-Brinell hardness and the hardness of plastics, and also supports multi-point inspection

Maximum table loading 100 kg  
 Maximum workpiece height 250 mm (with X-axis stage: 165 mm)  
 Depth (from indenter center) 220 mm  
 Test force 9.807 - 2452 N (1 - 250 kgf)

## Supports Rockwell and Brinell hardness testing on a single machine. Focused on usability on-the-ground.

The HR-600 Series, in addition to a standard Rockwell hardness testing model, offers machines with high added value that can test micro-Brinell hardness and the hardness of plastics as well, and also a lineup of models with Y-axis stage mobility that support fully automatic multi-point Rockwell hardness testing. Its key focus is on usability on the ground, where a wide range of materials — from metals to plastics — may need to be tested.



### HR-620B (PC TYPE)

The PC TYPE model allows users to view measurement data on large-screen PC monitors  
Other features are the same as HR-620B

Maximum table loading 100 kg  
Maximum workpiece height 250 mm (with X-axis stage: 165 mm)  
Depth (from indenter center) 220 mm  
Test force 9.807 - 2452 N (1 - 250 kgf)

Note: HR-620B in above photo shown with X-axis stage (optional) installed.



# DESIGN

## New design with functional beauty

With a table for mounting workpieces and head with vertical mobility, the HR-600 Series is built for operability and usability.

Its new design is highly focused on end-user usability, and the entire product structure has been inventively modified for functional beauty — a true embodiment of Mitutoyo's pioneering spirit.



# Design that pushes the boundaries of measurement diversity

## First Mitutoyo hardness testers with moving heads

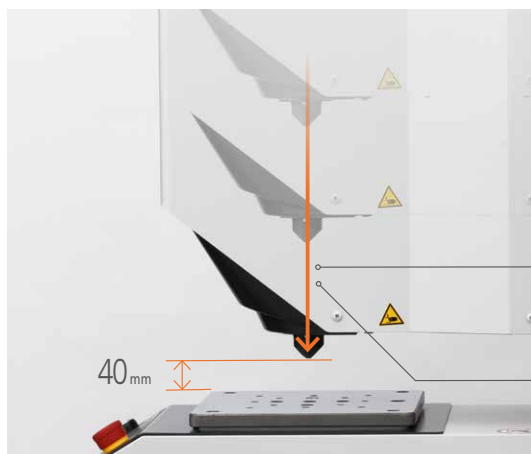

First Mitutoyo hardness testers ever to be equipped with moving heads (the head moves at a speed of 10 mm/s within a 210 mm range).

**210**mm

Movement along Z-axis [drive unit]

**10**mm/s

Speed along Z-axis [drive unit]

## Larger tables expand the range of measurements



Conventional size tables are too small and lack depth: large workpieces can not be measured.

Maximum loading 20 kg  
Depth (from indenter center) 150 mm



HR-600 tables are bigger and have more depth, allowing large workpieces to be mounted and measured as is.

Maximum loading 100 kg  
Depth (from indenter center) 220 mm

## Large workpieces can be mounted easily



Large workpieces such as cylinder blocks can be mounted on the table as is. Testing of heavy workpieces weighing up to 100 kg is supported.

# WORKPIECE



Supports testing of a wide range of workpiece, from metals to plastics

The HR-600 Series can test a wide variety of workpiece, ranging from those made of metal (crankshafts, cylinder blocks, etc.) to softer workpieces (brake pads, plastic parts, etc.), and supports both Rockwell and Brinell hardness testing on a single machine.



### Crank shaft



The head moves vertically during testing to avoid colliding with the workpiece. Installing a sliding jig onto the fixed stage allows for efficient testing.

### Plastic parts

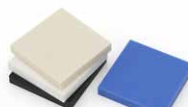
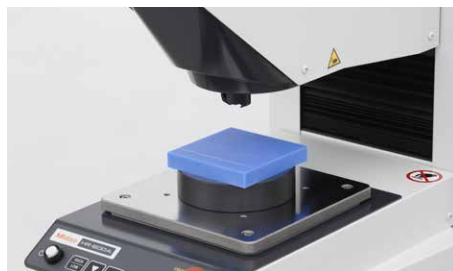

Allows users to set sequences as required by the standards for testing plastic hardness (i.e. applying, maintaining, and then removing the test load, and then reading the hardness value).

### Cylinder head



Large and heavy cylinder heads that were difficult to measure using hardness testers with elevating tables can now be mounted and measured on a fixed stage.

### Gear

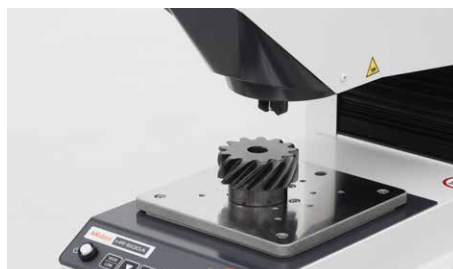

Post-heat treatment hardness of multiple parts of gears (tooth flank, face and tip, etc.) can be tested.\*

### Cylinder block



Large and heavy cylinder blocks that were difficult to measure using hardness testers with elevating tables can now be tested by mounting them on a fixed stage.

### Brake pads



Supports HRR and HRS, which use ball indenters, and other scales as well.\*

\* Models providing Y-axis stage mobility (for multi-point testing of a single specimen and simultaneous testing of multiple specimens) and X-axis stages (optional) also available.

# USABILITY

## Enhanced usability and operability effectively reduce measurement/analysis time

The display screen lets you view test results on the spot. You can choose from five displays (see page 11), according to what you need to view. The screens are touch-screen enabled to deliver excellent usability.

The HR-600 Series also offers many features useful for measurement and analysis, such as those that allow the user to directly select the hardness scale of their choice and statistical analysis features that can help them analyze multiple test results. Its enhanced usability will streamline your workflow by reducing measurement and analysis time and in other ways as well.





**Standard operating display**

Displays test results and conditions. All information can be viewed on a single screen.



**Simple display**

Displays test results and scales only, and provides an at-a-glance view of test conditions, making it suitable for tests that are repeated under the same conditions.



**Multi-point test display**

Navigation feature informs users of set test points. Users can perform multi-point tests, such as the Jominy test, through simple operations.



**List display (mean value)**

Displays the mean hardness value averaged over multiple points arbitrarily specified. The average of five test results is displayed in large font.

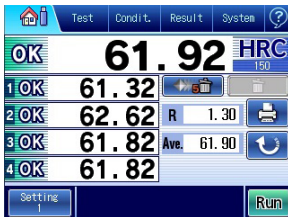

**List display (5-point display)**

Displays the five most recent test results in list format. Suited for checking the order and average values of test results, and also variations in the results.



**Direct hardness scale selection**

Users can directly select the hardness scale (determined by the test force and indenter) of their choice from the touch screen. The initial test force and total test force are automatically set according to the selected scale.



**Curved surface compensation feature**

The curved-surface correction function enables curved surfaces, such as round bars and concave or convex shapes, to be tested for hardness as easily as flat surfaces.



**Statistical analysis**

Quality management decisions based on hardness testing of industrial materials are made using multi-point test results. The statistical analysis feature, which can calculate the maximum, minimum, average, standard deviation and other values, is useful for analyzing multi-point test results.



Touch screen supports USB stick: export data and graphs as text and image files. Test results and statistical calculations results can be saved as text files, graphs can be saved as image files. X and Y positions can also be stored (X axis needed as minimum)

A touch screen that can toggle between different views enables excellent control of a rich palette of features.

# SOFTWARE AVPAK V3

Enables smooth and efficient measurements

AVPAK, using part programs, enables automated multi-point testing in the X-, Y- and Z-axis directions.

Supports Jominy test.

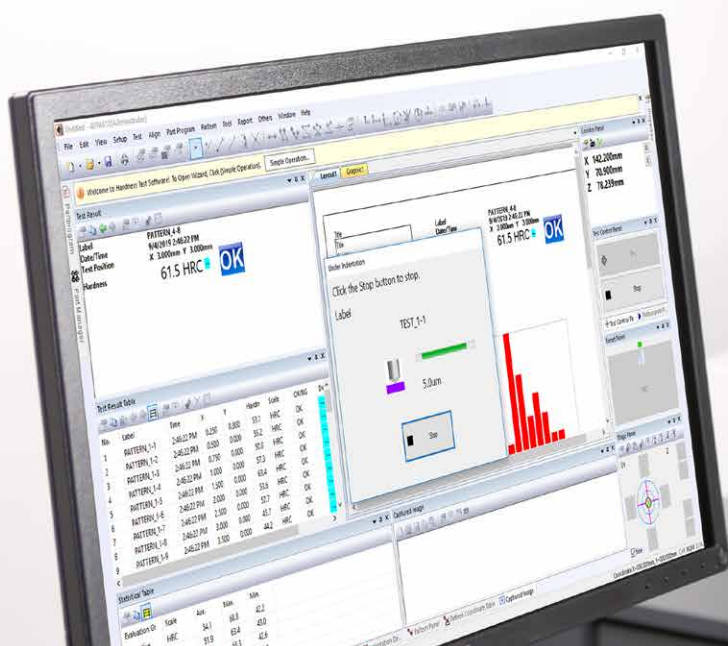

## Other software

For display unit type

### EXPAK

<Data Processing Software>

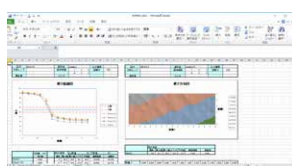

Software you can use to create test reports, perfect for evaluating hardened layers in steel alloys. Equipped with a two-dimensional distribution visualization feature useful for evaluating work hardening and residual stress.

### U-WAVE

<Measurement Data Wireless Communication System>

With the U-WAVE system, you can wirelessly send and import measurement data to commonly used software (Excel, notepad, etc.).

## AVPAK (Optional)

### FORMEio

<External Communication Program>



Software that enables external control of measuring instruments through PLC, allowing users to control them and monitor their status via RS-232C or LAN communication.

Note: FORMEio upgrades for AVPAK compatibility also available (V4.0 and later).

### MeasurLink

<Measurement Data Network System>

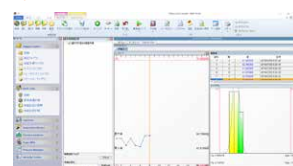

An IoT platform that visualizes quality by collecting data from measuring instruments in real time and then centrally managing and statistically processing this data.



# AUTOMATION

## Build a system that caters to the needs on the ground

By installing an X-axis stage on an HR-620B machine and creating a system that coordinates with robots, you can automate the testing procedure, from mounting workpieces to sorting them according to test results.



Example of Rockwell hardness testing machine automation on a production line

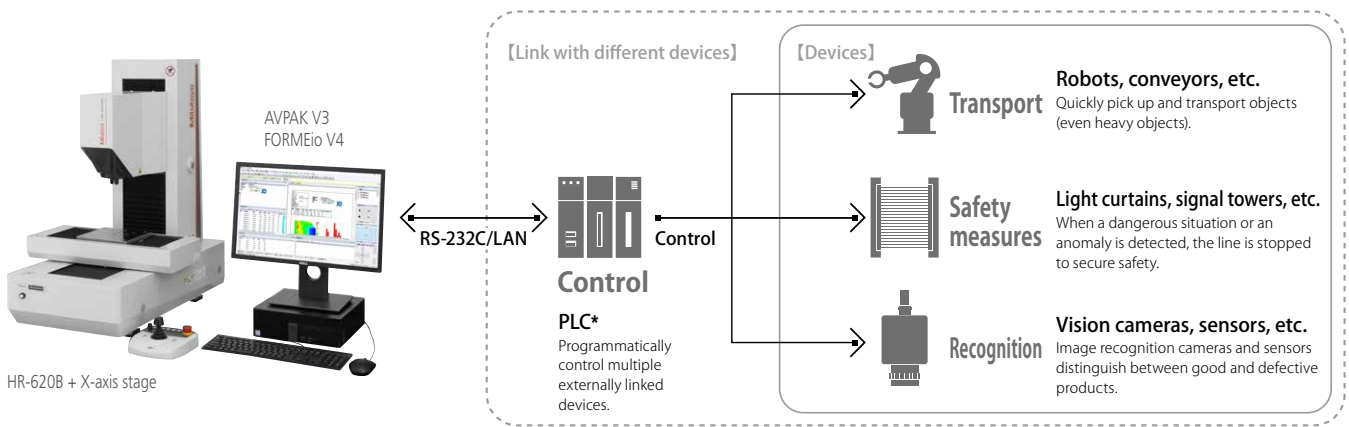

\* Programmable Logic Controller



# OPTION

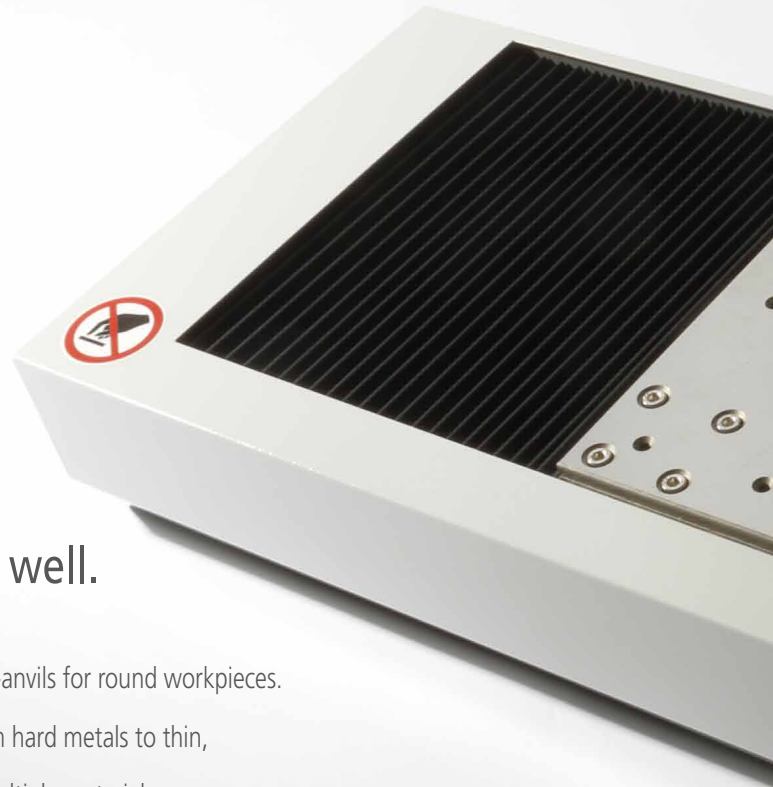

Enables testing of a wide range of materials and supports special tests as well.

We offer useful items such as PCs for remote operation software and V-anvils for round workpieces.

The HR-600 Series supports testing of a wide range of materials — from hard metals to thin, soft plastics — and also special tests, such as simultaneous testing of multiple materials.

## Testing machine rack A

Rack for standard-type HR-610A/HR-620A models.



Number of casters: 4  
Dimensions (WxDxH): 760x560x642 mm

## Display unit

Touch screen enabled color display with a rich choice of features. Standard accessory for HR-610A and HR-620A; special accessory for HR-620B.



## Control software AVPAK

Software that controls tests and handles their status and results, all as one consistent workflow.



## Testing machine rack B

Rack for HR-620B.



Number of casters: 4  
Dimensions (WxDxH): 910x820x642 mm

## X-axis stage

Two models, each with a different stage moving range (160 mm and 300 mm), are available.



Maximum loading: 50 kg

## V-anvil

For testing round specimens.



Minimum diameter: Ø20 mm  
Maximum diameter: Ø55 mm

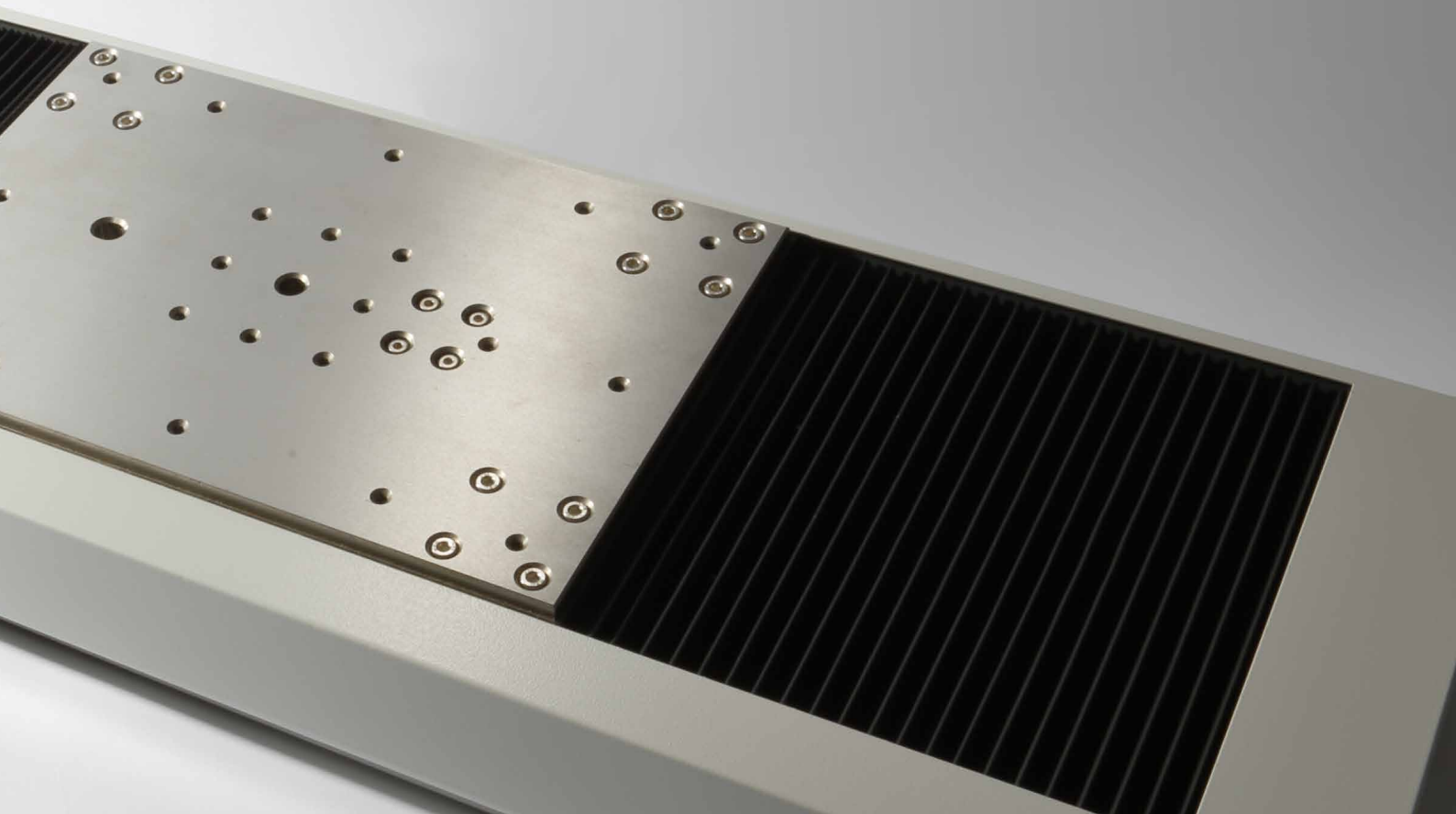

### Contact unit (large)

Used with Ø5 mm, Ø10 mm, Ø1/4 in., and Ø1/2 in. indenters.



### Carbide ball indenters (Brinell)

Four models (Ø1 mm, Ø2.5 mm, Ø5 mm, and Ø10 mm) for Brinell/HBT\* hardness testing.



\* Brinell depth measurement

### Digimatic Mini-Processor DP-1VA LOGGER

Small portable printer for statistical analysis and printing measurement data. Can store up to 1,000 pieces of data using its data logger feature. Can be connected to a PC using USB cable.



### Digimatic Gage/PC Data Input Device USB Input Tool Direct USB-ITN

Simply connect to your PC to import measurement data to Excel, notepad, etc.



### Measurement Data Wireless Communication System U-WAVE

Lets you easily import measurement data to your PC via wireless communication.



### Foot switch

Enables operator to start test sequence while keeping both hands free.



# OPTION



## Extension machine table

For big workpieces



Dimensions: 500x330

## Fast positioning rail

For fast repositioning  
It is easily attached to the extension table



## Levelling table

For angled workpieces

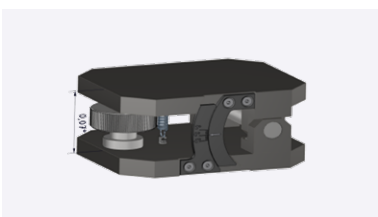

# SCALES AND TEST METHODS

Up to seven different hardness testing methods in a single unit.

This makes it a versatile tool ready to tackle tasks in production, goods inwards inspection and quality control in general.



## Rockwell test method

ISO 6508, ASTM E18, JIS 7726	Diamond	1,5875 mm Ball	3,175 mm Ball	6,35 mm Ball	12,7 mm Ball
Rockwell Scales	HRA	HRF	HRH	HRL	HRR
	HRD	HRB	HRE	HRM	HRS
	HRC	HRG	HRK	HRP	HRV
Rockwell Superficial Scales	HR15N	HR15T	HR15W	HR15X	HR15Y
	HR30N	HR30T	HR30W	HR30X	HR30Y
	HR45N	HR45T	HR45W	HR45X	HR45Y

## Rockwell test method for plastic materials

ISO 2039-2, ASTM D785, JIS K 7202	3,175 mm Ball	6,35 mm Ball	12,7 mm Ball
Rockwell Plastic Test Scales	HRE	HRL	HRR
	HRK	HRM	
Rockwell $\alpha$ Test			(HRR)

## Brinell test method

ISO 6506, ASTM E10, JIS 7724	1,0 mm Ball	2,5 mm Ball	5,0 mm Ball	10,0 mm Ball
Brinell Scales indentation only	HBW 1/1*	HBW 2.5/6.25	HBW 5/25	HBW 10/100
	HBW 1/2,5*	HBW 2.5/15.625	HBW 5/62.5	HBW 10/250*
	HBW 1/5	HBW 2.5/31.25	HBW 5/125	
	HBW 1/10	HBW 2.5/62.5	HBW 5/250*	
	HBW 1/30	HBW 2.5/187.5		

## Ball indentation for plastic materials

ISO 2039-1	5,0 mm Ball	5,0 mm Ball	5,0 mm Ball	5,0 mm Ball
Ball indentation	HB 49N*	HB 132N*	HB 358N*	HB 961N*

## Brinell depth measurement

VDI/VDE 2616-1 non standard	2.5 mm Ball
Brinell depth measurement	HBT 2.5/62.5
	HBT 2.5/187.5
	HBT 5/250*

## Vickers depth measurement

VDI/VDE 2616-1 non standard	Diamond
Vickers depth measurement	HVT 30*
	HVT 50*

\* HR-620A and HR-620B scales only

# SPECIFICATIONS & ACCESSORIES

## Tester (main unit)

Order No.	810-511-11	810-511-13	810-521-11	810-521-13	810-526-11
Model	HR-610A		HR-620A		HR-620B
Unit (display unit)	metric	inch/mm	metric	inch/mm	inch/mm
Indenter type *1	1/16" Tungsten carbide ball		1/16" Tungsten carbide ball		1/16" Tungsten carbide ball
Test force range	29.42 - 1839 N (3 - 187.5 kgf)		9.807 - 2452 N (1 - 250 kgf)		
Specimen height (Z-axis stroke)	40 - 250 mm (See "Testable workpieces")				
Testable workpieces	Minimum surface dimensions	18 x 4 mm (See Figure 1)			
	Minimum inner diameter of pipe-type workpiece	Ø400 mm (See Figure 2)			
	Concave workpiece	R25 mm or more, Height 20 mm or less (See Figure 3)			
	Minimum outside diameter	Ø20 mm (See Figure 4)			
Z-axis speed	Approx. 10 mm/s				
Maximum depth (from indenter center)	220 mm				
X-axis stroke	None (Option: 160 mm or 300 mm)				
Y-axis stroke	None				160 mm (±80 mm)
Y-axis speed	-				Approx. 50 mm/s
Y-axis feed error	-				±0.1 mm or less
Maximum table loading	100 kg				
Power supply	AC100 - 200 V 50/60 Hz				
Mass	176 kg		181 kg		205 kg

Note: Plastic testing may not be enabled depending on the material. For the test of Brinell hardness, indentation Brinell hardness, and plastic hardness, other special accessories are required.  
\*1 Supplied as standard.

unit: mm

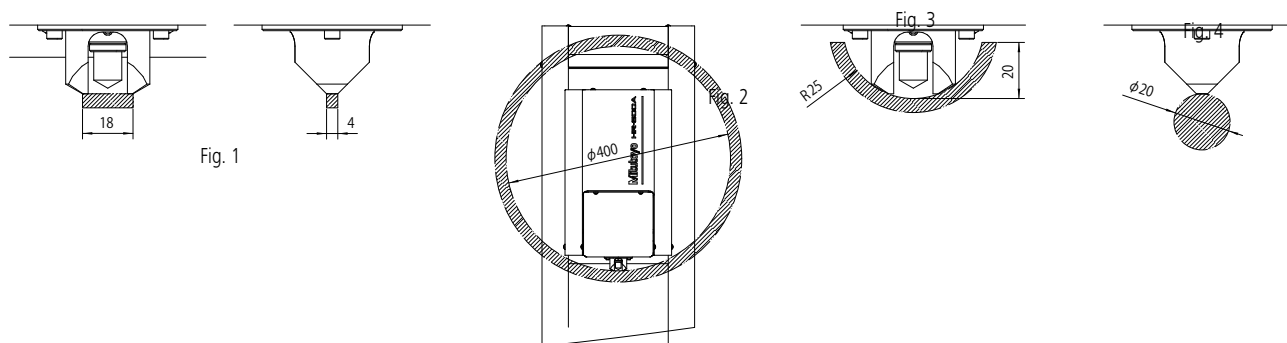

## Applicable standards and test force

Hardness testing methods	Rockwell	JIS B 7726, ISO 6508-2, ASTM E18			
	Brinell *2	JIS B 7724, ISO 6506-2, ASTM E10			
	Plastic	ISO 2039-1			
	Brinell depth measurement	JIS K 7202-2, ISO 2039-2, ASTM D785			
	Vickers depth measurement	VDI / VDE 2616			
Initial test force N (kgf)	Rockwell	29.42 (3) 98.07 (10)		9.807 (1)	
	Plastic	98.07 (10)			
	Indentation Brinell hardness	98.07 (10) 490.3 (50)			
	Indentation Vickers hardness	9.807 (1)			
Test force N (kgf)	Rockwell	147.1 (15) 294.2 (30) 441.3 (45) 588.4 (60) 980.7 (100) 1471 (150)			
	Brinell	49.03 (5) - 1839 (187.5)		9.807 (1) - 2452 (250)	
	Plastic	49.03 (5) 132.4 (13.5) 358.0 (36.5) 962.1 (98.1)			
	Indentation Brinell hardness	588.4 (60) 980.7 (100) 1471 (150)			
	Indentation Vickers hardness	612.9 (62.5) 1839 (187.5) 2452 (250)		294.2 (30) 490.4 (50)	

\*2 For Brinell hardness testing, an indenter (option) and a measurement microscope are required.



## Display unit

Display	Standard		Number of data displayed: 1, Hardness value, Scale, Test numbering, Hold time (Initial test force), Hold time (Total test force), Reading time, Hardness conversion, Judgment, Correction, Unit
	Simple		Number of data displayed: 1, Hardness value, Scale, Judgment, Correction
	List average / list		Number of data displayed: 5, Hardness value, Average hardness value, Hardness variation, Scale, Hardness conversion, Judgment, Correction
	Multipoint		Depending on set test points, Hardness value, Scale, Test numbering, Judgment, Correction, Unit
Calculation	GO / NG judgment function		Test results judged according to set maximum / minimum values
	Conversion function		Converts obtained test results to another scale
Correction functions	Curved surface compensation		Corrects results according to specimen shape (cylindrical, spherical, etc.)
	User correction	Shift	Corrects by increasing / decreasing value according to hardness value
		Multipoint	Corrects based on the results of tests conducted on multiple standard blocks (Rockwell/superficial only)
External output settings	Serial		For printer (RS-232C compliant) 1-ch
	Digimatic		Digimatic interface outputs 1-ch
	USB2.0		1-ch for PC communication / for USB memory
Languages			Supports the following 15 languages Japanese, English, German, French, Italian, Spanish, Korean, Chinese (simplified characters), Chinese (traditional characters), Turkish, Portuguese, Polish, Czech, Hungarian and Dutch
Hardness value	Digital display		Max. 7-digit (including decimal point and sign)
	Minimum reading		0.01 (settings can be changed)
Average hardness value			Average value of valid data
Hardness variation			Variations in valid data (Max. - Min. )
Scale			HRC/HR15N/HRB2.5/187.5 etc.
Test numbering			When testing a single specimen: 1, 2, 3... When testing a group of specimens: 1/5-1, 2/5-1, 3/5-1, 4/5-1, 5/5-1, 1/5-2, 2/5-2...
Hold time	Initial test force		1 - 120s (configurable in seconds)
	Total test force		1 - 120s (configurable in seconds)
Reading time			0 - 120s (configurable in seconds)
Hardness conversion			MITUTOYO HARD STEEL, SOFT METAL / SAE J417 T1 / ASTM E140 T1, T2, T4 ISO 18265 TA. 1/BS 860 T2, T3, T4
Judgment			OK, $\pm$ NG
Correction			Displays whether or not correction was applied: cylindrical, spherical, user (multipoint / shift correction)
Unit			mm (X-, Y- and Z-axis stage displacements)

## Standard accessories

Order No.	Description	Specifications	Qty
11PAA366	HR-600 accessory box		1
11AAD665	Booster	Ø120 mm	1
19BAA073	Diamond indenter	Dedicated to the Rockwell Superficial hardness test	1
11AAD465	1/16" carbide ball indenter		
19BAA507	Spare ball	Carbide ball 1/16"	
02ZAA020*	Power cord CEE		
02ZAA030*	Power cord BS		
11BAC135	Cable clamp CKN-13		3 (HR-610A/620A only)
			1 (HR-620B only)
538615	Allen wrench	Size 2.5 mm	1

\*Power cord is not included in scope of delivery. Please order additionally according to destination

## Software

Order No.	Description
11AAD522-DEE	AVPAK-20 V3.0 hardness testing software
12AAU424	FormEIO External control software
11AAC236	EXPAK Excel based report software
64AAB607R	MeasureLink V9 real time professional

## Optional accessories (Testing machine table, X-axis stage, etc.)

Order No.	Description	Remarks
11AAD668	Testing machine table A	For HR-610A/620A
11AAD671	Testing machine table B	For HR-620B
11AAD599	Display unit	HR-610A/620A is supplied as standard
810-530	160 mm X-axis stage (For A)	For HR-610A/620A
810-531	300 mm X-axis stage (For A)	For HR-610A/620A
810-535	160 mm X-axis stage (For B)	For HR-620B
810-536	300 mm X-axis stage (For B)	For HR-620B
K543390	Extended base plate 500 x 330 mm	
K543391	Guide rail for extended base plate K543390	
K543393	Leveling device for angled workpieces	
K543411	Anvil adaptor	
11AAD630	V anvil	
11AAD385	Contact unit (large)	
264-505D	Digimatic Mini-Processor DP-1VA LOGGER	
936937	Digimatic Mini-Processor DP-1VA LOGGER Connecting cable (1 m)	Digimatic Mini-Processor for DP-1VA LOGGER
02AGD600	Thermal printer DPU-414	
06AFM380D	USB Input Tool Direct USB-ITN-D	
02AZD730G	Measurement Data Wireless Communication System U-WAVE U-WAVE-T	IP67 type
02AZD880G	Measurement Data Wireless Communication System U-WAVE U-WAVE-T	Buzzer type
02AZD790D	Measurement Data Wireless Communication System U-WAVE U-WAVE-T Connecting cable	
02AZD810D	Measurement Data Wireless Communication System U-WAVE U-WAVE-R	
11AAD537	Foot switch	

## Indenter

### For Rockwell hardness test

Order No.	Description	Remarks
63DIA001	Diamond Indenter Rockwell ISO 6508-2 HRA HRC HRD HRN	DAkkS certificate and Function test Table 4
63DIA021	Diamond Ind. Rockwell ISO 6508-2 HRA HRC HRD	DAkkS certificate and Function test Table 5
63DIA022	Diamond Ind. Rockwell Superficial ISO 6508-2 HRN	DAkkS certificate and Function test Table 6
63DIA002	Diamond Ind. Rockwell ISO 6508-2	DAkkS cert. without Function test
63DIA004	Diamond Indenter Rockwell ASTM E-18	DAkkS certificate and Function test
11AAD465	1.5875 mm carbide ball indenter	
11AAD466	3.175 mm carbide ball indenter	
11AAD735	6.35 mm carbide ball indenter	
11AAD742	12.7 mm carbide ball indenter	
19BAA507	Carbide ball (spare) 1.5875 mm	without calibration, 1 pc.
19BAA508	Carbide ball (spare) 3.175 mm	without calibration, 1 pc.
19BAA509	Carbide ball (spare) 6.35 mm	without calibration, 1 pc.
19BAA510	Carbide ball (spare) 12.7 mm	without calibration, 1 pc.
63BAL005	Carbide Ball Rockwell ISO 6508-2 Ø1.5875 mm	DAkkS certificate, 1pc.
63BAL006	Carbide Ball Rockwell ISO 6508-2 Ø3.175 mm	DAkkS certificate, 1pc.
63BAL013	Carbide Ball Rockwell ASTM E-18 Ø1.5875 mm	DAkkS certificate, 1pc.
63BAL014	Carbide Ball Rockwell ASTM E-18 Ø3.185 mm	DAkkS certificate, 1pc.
63BAL015	Carbide Ball Rockwell ASTM E-18 Ø6.35 mm	DAkkS certificate, 1pc.
63BAL016	Carbide Ball Rockwell ASTM E-18 Ø12.7 mm	DAkkS certificate, 1pc.

### For Plastic hardness test

Order No.	Description	Remarks
11AAD461	1.5875 mm steel ball indenter	
11AAD462	3.175 mm steel ball indenter	
11AAD733	6.35 mm steel ball indenter	
11AAD734	12.7 mm steel ball indenter	
19BAA082	Steel ball (spare) 1.5875 mm	without calibration, 10 pcs./set
19BAA083	Steel ball (spare) 3.175 mm	without calibration, 10 pcs./set
19BAA084	Steel ball (spare) 6.35 mm	without calibration, 10 pcs./set
19BAA085	Steel ball (spare) 12.7 mm	without calibration, 10 pcs./set

### For Brinell/HBT HBD\* hardness test

Order No.	Description	Remarks
11AAD721	Carbide ball indenter Ø1 mm	
11AAD722	Carbide ball indenter Ø2.5 mm	
11AAD723	Carbide ball indenter Ø5 mm	
11AAD724	Carbide ball indenter Ø10 mm	
19BAA281	Ø1 mm carbide ball	without calibration, 1 pc.
19BAA283	Ø2.5 mm carbide ball	without calibration, 1 pc.
19BAA162	Ø5 mm carbide ball	without calibration, 1 pc.
19BAA163	Ø10 mm carbide ball	without calibration, 1 pc.
63BAL001	Carbide Ball Brinell ISO 6506-2 Ø1.0 mm	DAkkS certificate, 1pc.
63BAL002	Carbide Ball Brinell ISO 6506-2 Ø2.5 mm	DAkkS certificate, 1pc.
63BAL003	Carbide Ball Brinell ISO 6506-2 Ø5.0 mm	DAkkS certificate, 1pc.
63BAL004	Carbide Ball Brinell ISO 6506-2 10.0 mm	DAkkS certificate, 1pc.
63BAL005	Carbide Ball Brinell ASTM E-10 Ø1.0 mm	DAkkS certificate, 1pc.
63BAL006	Carbide Ball Brinell ASTM E-10 Ø2.5 mm	DAkkS certificate, 1pc.
63BAL007	Carbide Ball Brinell ASTM E-10 Ø5.0 mm	DAkkS certificate, 1pc.
63BAL008	Carbide Ball Brinell ASTM E-10 Ø10.0 mm	DAkkS certificate, 1pc.

\*Brinell depth measurement

### For HVT HVD\* hardness test

Order No.	Description	Remarks
11AAE254	HVT indenter	Dedicated to HVT

\*Vickers depth measurement

Dimensions

HR-610A, HR-620A

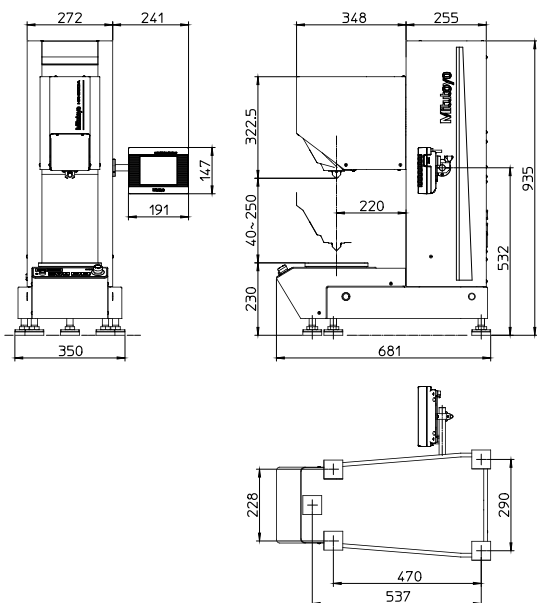

HR-620B

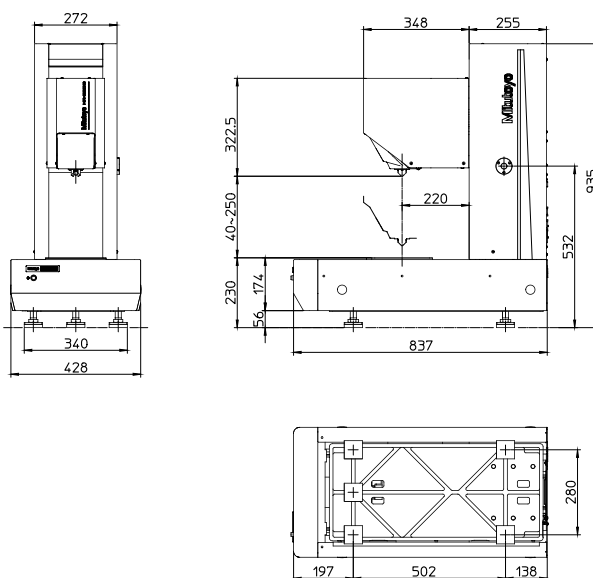

HR-620B + 160 mm X-axis stage

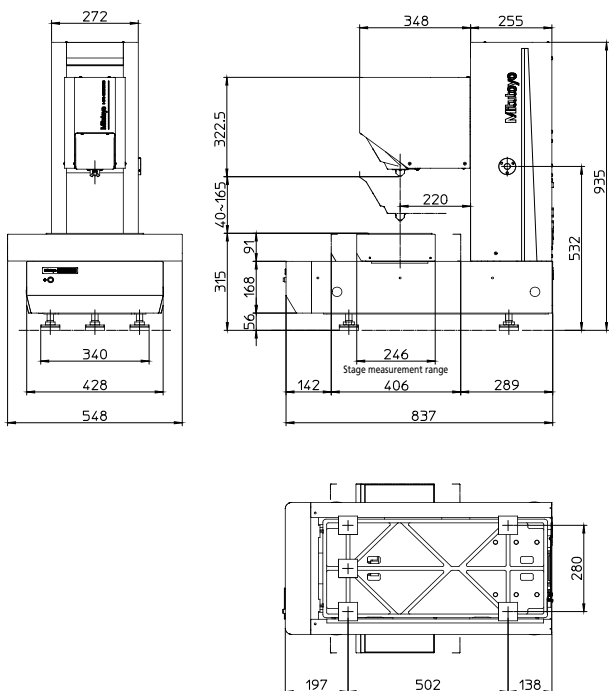

HR-620B + 300 mm X-axis stage

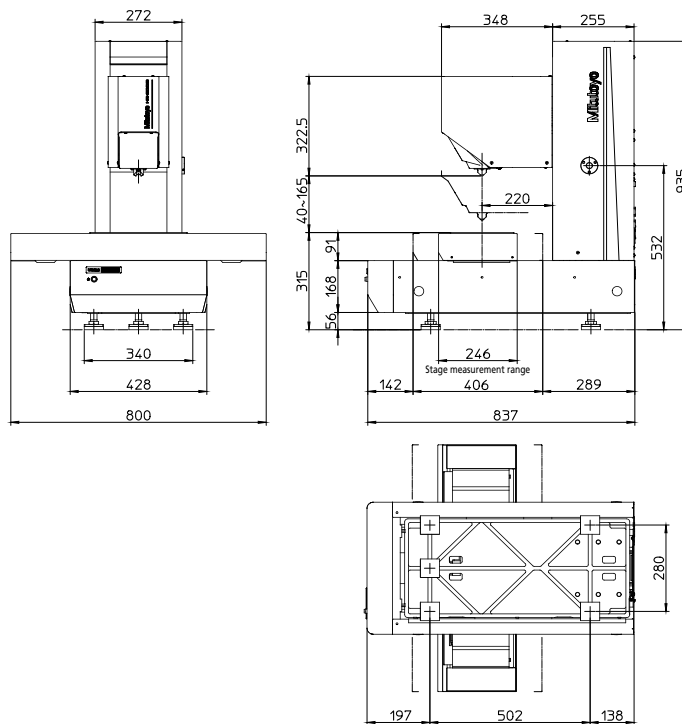





## Brinell

Order no.	Value and scale	Certificate, dimensions and material
<b>HBW</b>		
63ETB196	80HBW 1/2,5 HTB Brinell non standard	with DAkkS certificate 60x60x16mm alu.
<b>HBW 1/5</b>		
63ETB210	80HBW 1/5 HTB Brinell ISO 6506-3	with DAkkS certificate 60x60x16mm alu.
63ETB211	110HBW 1/5 HTB Brinell non standard	with DAkkS certificate 60x60x16mm alu.
63ETB212	130HBW 1/5 HTB Brinell non standard	with DAkkS certificate 60x60x16mm alu.
<b>HBW 1/10</b>		
63ETB224	80HBW 1/10 HTB Brinell ISO 6506-3	with DAkkS certificate 60x60x16mm alu.
63ETB225	110HBW 1/10 HTB Brinell ISO 6506-3	with DAkkS certificate 60x60x16mm alu.
63ETB226	130HBW 1/10 HTB Brinell ISO 6506-3	with DAkkS certificate 60x60x16mm alu.
63ETB227	160HBW 1/10 HTB Brinell ISO 6506-3	with DAkkS certificate 60x60x16mm alu.
63ETB228	200HBW 1/10 HTB Brinell ISO 6506-3	with DAkkS certificate 60x60x16mm steel
63ETB229	250HBW 1/10 HTB Brinell non standard	with DAkkS certificate 60x60x16mm steel
<b>HBW 1/30</b>		
63ETB239	110HBW 1/30 HTB Brinell ISO 6506-3	with DAkkS certificate 60x60x16mm alu.
63ETB240	130HBW 1/30 HTB Brinell ISO 6506-3	with DAkkS certificate 60x60x16mm alu.
63ETB241	160HBW 1/30 HTB Brinell ISO 6506-3	with DAkkS certificate 60x60x16mm alu.
63ETB242	200HBW 1/30 HTB Brinell ISO 6506-3	with DAkkS certificate 60x60x16mm steel
63ETB243	250HBW 1/30 HTB Brinell ISO 6506-3	with DAkkS certificate 60x60x16mm steel
63ETB244	300HBW 1/30 HTB Brinell ISO 6506-3	with DAkkS certificate 60x60x16mm steel
63ETB245	350HBW 1/30 HTB Brinell ISO 6506-3	with DAkkS certificate 60x60x16mm steel
63ETB246	400HBW 1/30 HTB Brinell ISO 6506-3	with DAkkS certificate 60x60x16mm steel
63ETB247	450HBW 1/30 HTB Brinell ISO 6506-3	with DAkkS certificate 60x60x16mm steel
63ETB248	500HBW 1/30 HTB Brinell ISO 6506-3	with DAkkS certificate 60x60x16mm steel
63ETB249	550HBW 1/30 HTB Brinell ISO 6506-3	with DAkkS certificate 60x60x16mm steel
63ETB250	600HBW 1/30 HTB Brinell ISO 6506-3	with DAkkS certificate 60x60x16mm steel
<b>HBW 2,5/15,625</b>		
63ETB267	80HBW 2,5/15,625 HTB Brinell non stand.	with DAkkS certificate 60x60x16mm steel
<b>HBW 2,5/31,25</b>		
63ETB282	80HBW 2,5/31,25 HTB Brinell ISO 6506-3	with DAkkS certificate 60x60x16mm alu.
63ETB283	110HBW 2,5/31,25 HTB Brinell non stand.	with DAkkS certificate 60x60x16mm alu.
63ETB285	130HBW 2,5/31,25 HTB Brinell non stand.	with DAkkS certificate 60x60x16mm alu.
<b>HBW 2,5/62,5</b>		
63ETB299	80HBW 2,5/62,5 HTB Brinell ISO 6506-3	with DAkkS certificate 60x60x16mm alu.
63ETB301	110HBW 2,5/62,5 HTB Brinell ISO 6506-3	with DAkkS certificate 60x60x16mm alu.
63ETB302	130HBW 2,5/62,5 HTB Brinell ISO 6506-3	with DAkkS certificate 60x60x16mm alu.
63ETB303	160HBW 2,5/62,5 HTB Brinell ISO 6506-3	with DAkkS certificate 60x60x16mm alu.
63ETB304	200HBW 2,5/62,5 HTB Brinell ISO 6506-3	with DAkkS certificate 60x60x16mm steel
63ETB305	250HBW 2,5/62,5 HTB Brinell ISO 6506-3	with DAkkS certificate 60x60x16mm steel
<b>HBW 2,5/187,5</b>		
63ETB315	110HBW 2,5/187,5 HTB Brinell ISO 6506-3	with DAkkS certificate 60x60x16mm alu.
63ETB316	130HBW 2,5/187,5 HTB Brinell ISO 6506-3	with DAkkS certificate 60x60x16mm alu.
63ETB317	160HBW 2,5/187,5 HTB Brinell ISO 6506-3	with DAkkS certificate 60x60x16mm alu.
63ETB318	200HBW 2,5/187,5 HTB Brinell ISO 6506-3	with DAkkS certificate 60x60x16mm steel
63ETB319	250HBW 2,5/187,5 HTB Brinell ISO 6506-3	with DAkkS certificate 60x60x16mm steel
63ETB320	300HBW 2,5/187,5 HTB Brinell ISO 6506-3	with DAkkS certificate 60x60x16mm steel
63ETB321	350HBW 2,5/187,5 HTB Brinell ISO 6506-3	with DAkkS certificate 60x60x16mm steel
63ETB322	400HBW 2,5/187,5 HTB Brinell ISO 6506-3	with DAkkS certificate 60x60x16mm steel
63ETB323	450HBW 2,5/187,5 HTB Brinell ISO 6506-3	with DAkkS certificate 60x60x16mm steel
63ETB324	500HBW 2,5/187,5 HTB Brinell ISO 6506-3	with DAkkS certificate 60x60x16mm steel
63ETB325	550HBW 2,5/187,5 HTB Brinell ISO 6506-3	with DAkkS certificate 60x60x16mm steel
63ETB326	600HBW 2,5/187,5 HTB Brinell ISO 6506-3	with DAkkS certificate 60x60x16mm steel
<b>HBW 5/62,5</b>		
63ETB343	80HBW 5/62,5 HTB Brinell ISO 6506-3	with DAkkS certificate 60x60x16mm alu.
<b>HBW 5/125</b>		
63ETB358	80HBW 5/125 HTB Brinell ISO 6506-3	with DAkkS certificate 60x60x16mm alu.
63ETB359	110HBW 5/125 HTB Brinell ISO 6506-3	with DAkkS certificate 60x60x16mm alu.
63ETB360	130HBW 5/125 HTB Brinell ISO 6506-3	with DAkkS certificate 60x60x16mm alu.
<b>HBW 5/250</b>		
63ETB387	80HBW 5/250 HTB Brinell ISO 6506-3	with DAkkS certificate 150x100x16mm alu.
63ETB388	110HBW 5/250 HTB Brinell ISO 6506-3	with DAkkS certificate 150x100x16mm alu.
63ETB389	130HBW 5/250 HTB Brinell ISO 6506-3	with DAkkS certificate 150x100x16mm alu.
63ETB390	160HBW 5/250 HTB Brinell ISO 6506-3	with DAkkS certificate 150x100x16mm alu.
63ETB391	200HBW 5/250 HTB Brinell non standard	with DAkkS certificate 150x100x16mm steel
63ETB392	250HBW 5/250 HTB Brinell non standard	with DAkkS certificate 150x100x16mm steel
<b>HBW 10/250</b>		
63ETB418	80HBW 10/250 HTB Brinell ISO 6506-3	with DAkkS certificate 150x100x16mm alu.



### Mitutoyo reference materials:

- First-class quality Made in Germany
- Independent DAkkS calibration according to DIN EN ISO in an accredited laboratory
- Multiple calibrations (up to 3 scales on one test block), surface grid and calibrations according to ASTM on request
- Large square or rectangular surface with large
- Space advantage over triangular or round test blocks
- Short delivery time
- MPE "Maximum Permitted Error" of the hardness testing system engraved – all relevant information at a glance

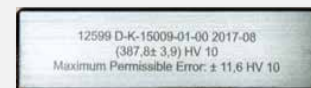

For a wider selection of hardness testblocks, in all scales and test methods, please request our **hardness test block PRE1477 brochures**. All test blocks are Made in Germany and supplied with certificate and protective case.



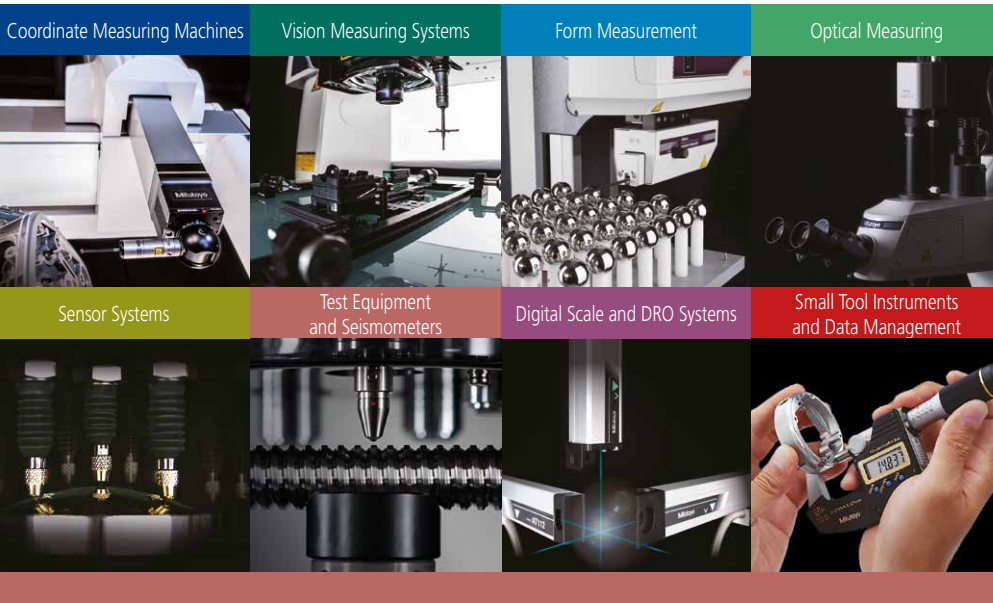

**Whatever your challenges are,  
Mitutoyo supports you from start to finish.**

Mitutoyo is not only a manufacturer of top quality measuring products but one that also offers qualified support for the lifetime of the equipment, backed up by comprehensive services that ensure your staff can make the very best use of the investment.

Apart from the basics of calibration and repair, Mitutoyo offers product and metrology training, as well as IT support for the sophisticated software used in modern measuring technology. We can also design, build, test and deliver bespoke measuring solutions and even, if deemed cost-effective, take your critical measurement challenges in-house on a sub-contract basis.

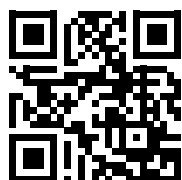

**Find additional product literature  
and our product catalogue**

[www.mitutoyo.eu](http://www.mitutoyo.eu)

**Note:** Product illustrations are without obligation. Product descriptions, in particular any and all technical specifications, are only binding when explicitly agreed upon.  
MITUTOYO and MiCAT are either registered trademarks or trademarks of Mitutoyo Corp. in Japan and/or other countries/regions. Other product, company and brand names mentioned herein are for identification purposes only and may be the trademarks of their respective holders.

**Mitutoyo**

**Mitutoyo Europe GmbH**

Borsigstraße 8-10  
41469 Neuss

Tel. +49 (0) 2137-102-0  
Fax +49 (0) 2137-102-351

[info@mitutoyo.eu](mailto:info@mitutoyo.eu)  
[www.mitutoyo.eu](http://www.mitutoyo.eu)