

## QM-HEIGHT SERIES

HIGH-PERFORMANCE HEIGHT GAUGE

SMALL TOOL INSTRUMENTS  
AND DATA MANAGEMENT



# High-Performance Height Gauge QM-Height Series

- **Best-in-class accuracy  $\pm(2.4+2.1L/600)\mu\text{m}$**
- **Built-in air suspension feature mechanism using an internal pump enables smooth movement over a surface plate.**  
(Lower-cost version without air suspension also available)
- **Easy-to-view, simple control panel enables main measurements with a single keystroke.**
- **A battery life of 300 hours\* in continuous use from four alkaline batteries.**  
(Also works with four NiMH (AA/HR6) rechargeable batteries)
- **A full range of accessories provide enhanced operability, including a variety of probe contact points and the USB Input Tool Direct, which allows output to PC-based software.**

\* Does not apply when air suspension feature is used. See specification.

## GO/ $\pm$ NG judgement by LED (red, orange, green) and measurement examples

- LEDs indicate tolerance judgement status – green for GO, red for +NG, and orange for -NG. “-NG”, “GO” and “+NG” also appear on the display.



## Simple button layout and user-friendly icon keys

- Frequently used keys are indicated with icons.
- An ergonomic cross-key configuration enhances operability for setting presets and other settings.

## Inside/outside diameters, maximum/minimum heights and displacement can be measured using a standard probe

- Besides height measurement, Mitutoyo's proprietary mechanism and firmware enables scanning measurement of inside/outside diameters, maximum/minimum heights, and height differences.



QM-Height measures height as well as step, inside/outside widths, inside/outside diameters, circle pitch and also measures free-form surface maximum/minimum heights and height difference by scanning measurement\*.

QM-Height also remembers the immediately preceding measurement and displays the difference (pitch) between results.

\*Scanning measurement stroke is approx 1mm above and below from the start point of measurement.

## Measurement system based on an ABSOLUTE electromagnetic induction linear encoder

- Remembers an origin point once it has been set so it does not have to be reset each time the system is turned on.

## External output

- Digimatic and USB ports are provided as standard.



When attaching a U-WAVE transmitter it is advisable to use the optional mounting plate (No. 02AZE990).



## Power supply

- Four alkaline AA/LR6 batteries (standard accessories)
- Also operates on four NiMH AA rechargeable batteries
- AC adapter (optional accessory)

## Probe elevation wheel

- Used for measurement, allowing fine or coarse adjustment of probe height.

## Air-suspension feature

- Pressing a button on the grip activates the internal air pump. The base rises on a cushion of air and can be moved smoothly over the surface plate. Measurements should not be made while this function is in use as it will cause measurement error.



## Operation keys

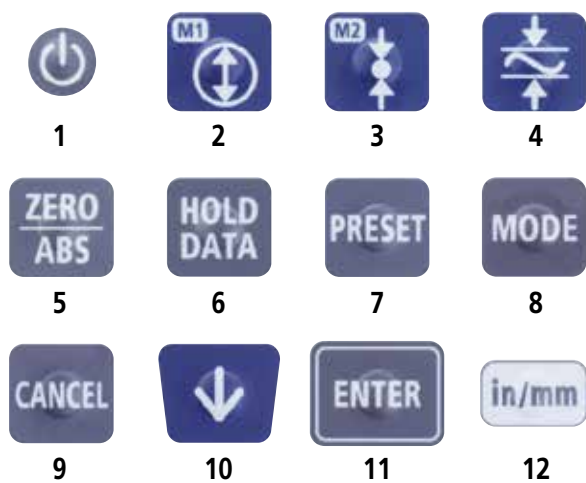

	Function	
1		Turns the power on and off.
2		Enters the inside diameter measurement mode.
3		Enters the outside diameter measurement mode.
4		Enters the scanning measurement mode.
5		Switches the measuring mode between INCremental and ABSolute.
6		Holds a measurement value or outputs data.
7		Sets a preset value.
8		Displays mode choices.
9		Cancels the current operation.
10		Changes digits or setting item.
11		Confirms the operation.
12		Switches the unit between "inch" and "mm". (Only for inch-unit supported models.)

## Circle (hole) measurement example

- 1) Press (the down-pointing arrow flashes on the screen to indicate contact direction).
- 2) Move the probe inside the hole (a) to the required depth.
- 3) Bring the probe into contact with the bottom surface of the hole (b) until the buzzer sounds.  
Hold the adjustment wheel stationary.
- 4) Move the main unit, or workpiece, so that the probe tracks across the bottom surface of the hole.
- 5) Press when the display value stops changing (the scanning function has locked onto the minimum value).
- 6) Move the probe away from the lower surface of the hole (the up-pointing arrow flashes on the screen) and apply steps 3, 4 and 5 to find the maximum height value on the upper surface of the hole (c).
- 7) Press to display the measured value.

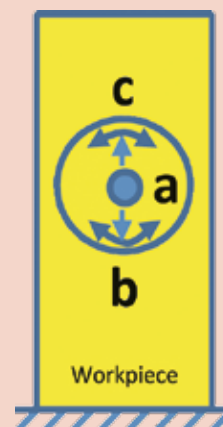

## Display layout

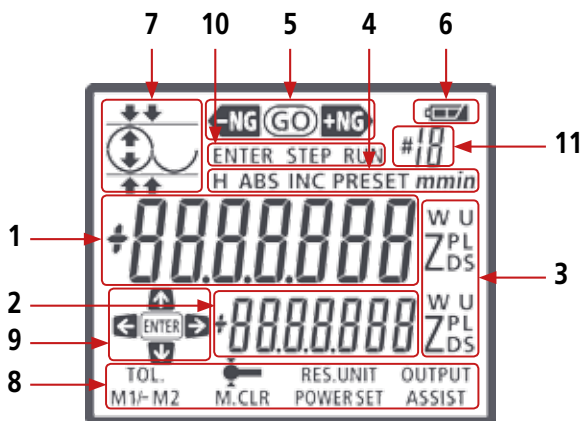

- |    |   |
|----|---|
| 1  | Main measurement value  |
| 2  | Auxiliary measurement value   |
| 3  | Auxiliary measurement indicators - ZP (pitch), ZD (dia.), ZL (max. value), ZS (min. value), W (width), U (Tol. upper limit), L (Tol. lower limit) |
| 4  | Measurement system, Preset, Unit, Hold (H)  |
| 5  | Tolerance judgement   |
| 6  | Low-battery warning   |
| 7  | Guidance icons  |
| 8  | Mode selection  |
| 9  | Status of the assist function   |
| 10 | Status of the assist function   |
| 11 | Assist function number  |

## Measurement examples

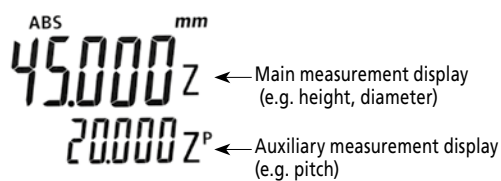
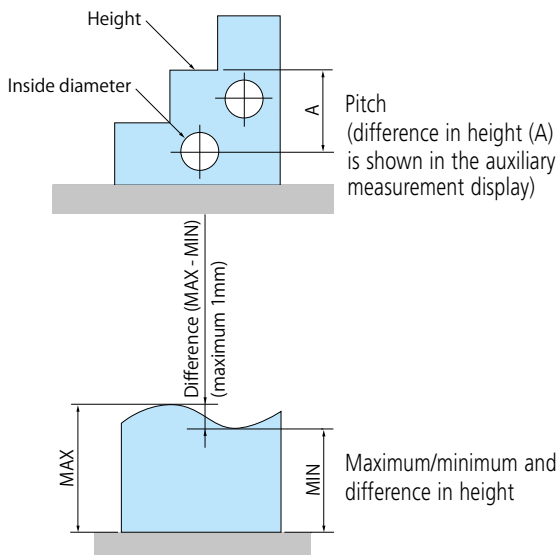

## Height measurement example

- 1) Set the ABS origin relative to the surface plate.
- 2) Bring the probe into contact with the top surface of the workpiece until the buzzer sounds.
- 3) The symbol H appears and the measurement result is displayed.
- 4) To continue height measurement, repeat the procedure from step 2).

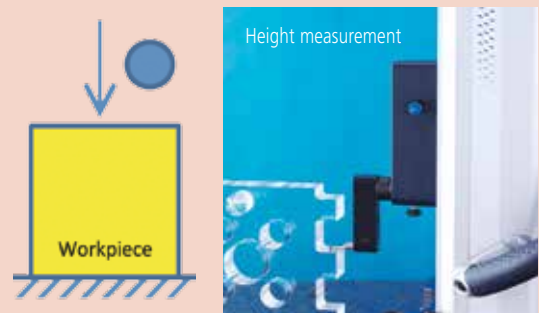

## SPECIFICATIONS

Code No.		518-230	518-232	518-234	518-236
Measuring range		0 - 350 mm	0 - 600 mm	0 - 350 mm	0 - 600 mm
Resolution (selectable)		0.001 mm/ 0.005 mm	0.001 mm/ 0.005 mm	0.001 mm/ 0.005 mm	0.001 mm/ 0.005 mm
Accuracy at 20°C	Measurement <sup>*1</sup>	$\pm (2.4+2.1L/600) \mu\text{m}$			
	Repeatability <sup>*1</sup>				
Perpendicularity <sup>*2</sup> (20°C)		7 $\mu\text{m}$	12 $\mu\text{m}$	7 $\mu\text{m}$	12 $\mu\text{m}$
Guiding method		Roller bearing			
Drive method		Manual (wheel)			
Measurement principle		Electromagnetic induction absolute encoder			
Measuring force		1.5±0.5 N			
Data output ports		Digimatic / USB <sup>*3</sup>			
Air-suspension feature		Not included		Included (for positioning only) <sup>*4</sup>	
Power supply		Alkaline AA/LR6 batteries x 4 (standard accessories) / AC adapter (optional accessory) / Supports NiMH (HR6) rechargeable batteries x 4			
Battery life guidelines <sup>*5</sup>		Approx. 300 hours (continuous use) LED: Other than full-time illumination		Approx. 300 hours (continuous use) LED: Other than full-time illumination	
		Approx. 100 hours (continuous use) LED: Full-time illumination		Approx. 3.3 days when the air-suspension feature is used for 0.5 hours/day.	
Mass		25 kg	29 kg	26 kg	30 kg
Size (mm)		Stroke 350 mm type: 280(W)x273(D)x784(H) mm Stroke 600 mm type: 280(W)x273(D)x1016(H) mm			
Operating temperature range (recommended)		0 – 40°C (10 – 30°C)			
Operating temperature range		20 - 80% RH (Must be free from condensation)			
Storage temperature range		-10°C – 50°C			
Storage humidity range		5 - 90% RH (Must be free from condensation)			

\*1 The indication accuracy and repeatability represent the values obtained from the height measurement of a flat surface using the standard holder with  $\phi 5$  ball contact point. In the case of diameter, minimum (maximum) value, circle pitch or difference measurement, measuring errors may be larger than the accuracy ratings listed in the table due to variations in measuring force during a scanning measurement, which differs from height measurement.

\*2 Indicates the value obtained from the measurement of a straight surface placed perpendicular to the the base reference surface using the Lever Head (MLH-321) and Mu-checker (M-411).

\*3 Requires special communication driver and software. Consult your local Mitutoyo Sales Office for details.  
These can be downloaded from the Mitutoyo web site: <http://mitutoyo.eu/index.php?cID=4249>

\*4 When using a model with the air-suspension feature, it is advisable to use a JIS 1 class, or higher, surface plate. Using on surfaces with scratches or unevenness may prevent the system operating to the specified performance.

\*5 Battery life depends on the operating conditions. In particular, it is more economical to use the optional AC adapter to power the instrument if the application requires prolonged use of the air-suspension feature.

## DIMENSIONS

Unit: mm

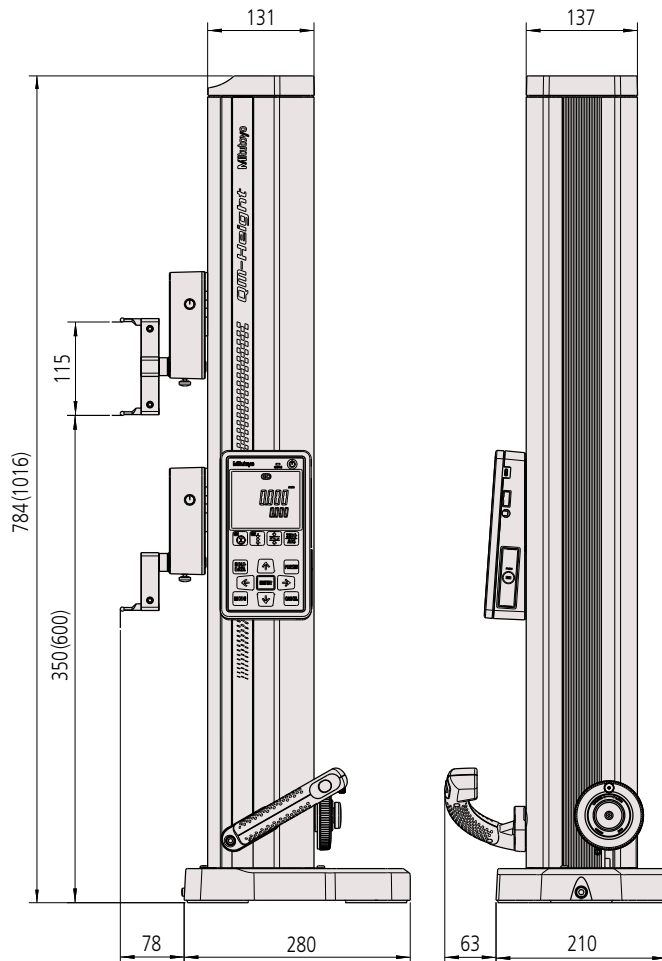

( ): Range 0-600 mm

## Diverse options expand measurement possibilities

Part no.	Item
<b>Depth measurement</b>	
<b>12AAC072</b>	Depth probe
<b>Interchangeable contact points for ø5mm stepped probe</b>	
<b>957261</b>	ø2 mm ball (coaxial type)
<b>957262</b>	ø3 mm ball (coaxial type)
<b>957263</b>	ø4 mm ball (coaxial type)
<b>957264</b>	ø14 mm disk
<b>957265</b>	ø20 mm disk
<b>12AAA788</b>	ø4 mm ball (eccentric type)
<b>12AAA789</b>	ø6 mm ball (eccentric type)
<b>Special Holder, Special Probe</b>	
<b>12AAA792</b>	Holder for Dial Gage
<b>12AAA793</b>	Long holder
<b>AC adapter</b>	
<b>06AEG180D</b>	AD620D (EUROPE)
<b>06AEG180E</b>	AD620E (U.K.)
<b>Digimatic cable</b>	
<b>936937</b>	1m
<b>965014</b>	2m
<b>Others</b>	
<b>05HZA143</b>	9 mm × 9 mm adapter (requires the following clamp)
<b>05GZA033</b>	Clamp (for 9 mm × 9 mm adapter)
<b>05HZA144</b>	6.35 mm × 12.7 mm adapter (requires the following clamp assembly)
<b>901385</b>	Clamp (for 6.35 mm × 12.7 mm adapter)
<b>02AZE990</b>	U-WAVE mounting plate

\* A gauge block may be required for zero-setting depending on the probe and contact point.

\* Scriber can't be used.

## Standard accessories

- Probe diameter calibration block
- ø5 mm stepped probe
- Alkaline batteries x 4 (AA/LR6)





**Whatever your challenges are,  
Mitutoyo supports you from start to finish.**

Mitutoyo is not only a manufacturer of top quality measuring products but one that also offers qualified support for the lifetime of the equipment, backed up by comprehensive services that ensure your staff can make the very best use of the investment.

Apart from the basics of calibration and repair, Mitutoyo offers product and metrology training, as well as IT support for the sophisticated software used in modern measuring technology. We can also design, build, test and deliver bespoke measuring solutions and even, if deemed cost-effective, take your critical measurement challenges in-house on a sub-contract basis.



**Find additional product literature  
and our product catalogue**

[www.mitutoyo.eu](http://www.mitutoyo.eu)

**Note:** Product illustrations are without obligation. Product descriptions, in particular any and all technical specifications, are only binding when explicitly agreed upon.  
MITUTOYO and MiCAT are either registered trademarks or trademarks of Mitutoyo Corp. in Japan and/or other countries/regions. Other product, company and brand names mentioned herein are for identification purposes only and may be the trademarks of their respective holders.

# Mitutoyo

**Mitutoyo Europe GmbH**

Borsigstraße 8-10  
41469 Neuss

Tel. +49 (0) 2137-102-0  
Fax +49 (0) 2137-102-351

[info@mitutoyo.eu](mailto:info@mitutoyo.eu)  
[www.mitutoyo.eu](http://www.mitutoyo.eu)