

Fine Pitch Micrometer Heads

(0.1mm Pitch)

Catalog No. E4279-148



Fine Pitch Micrometer Heads

(0.1mm Pitch)

New, high-precision thread machining technology has made possible a new thimble design incorporating a highly accurate screw with a pitch of 0.1mm. This is only one-fifth of the conventional micrometer pitch of 0.5mm and provides a feed of just 0.1mm per thimble revolution. Since the external dimensions of these heads are compatible with conventional 0.5mm pitch heads, conventional types can be easily replaced with these new heads to provide extra-fine adjustment, or measurement resolution, when and where needed.

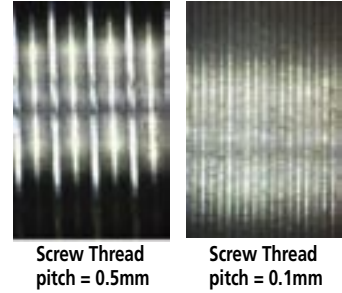

Screw Thread
pitch = 0.5mm

Screw Thread
pitch = 0.1mm



Applications

Semiconductor-wafer positioning machinery and optical component alignment units, etc.

- Precision X-Y table positioning
- Precision adjustment of mirror in holder

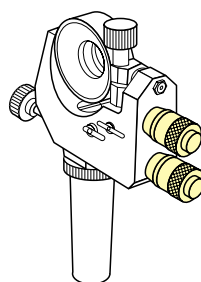
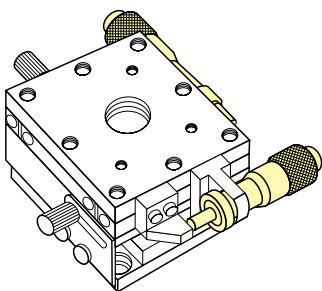

Comparison of mounting dimensions between a standard fine-pitch head and a standard conventional pitch head at the mid-range travel position

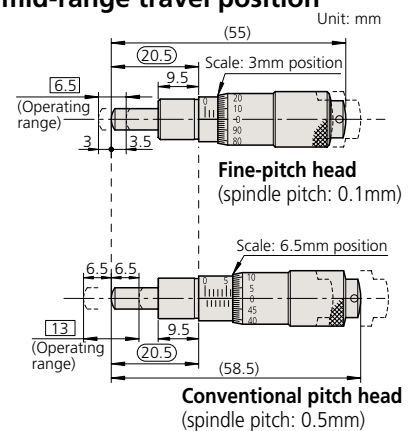

While the fine-pitch micrometer head has a measuring range of 6.5mm, the conventional head has a larger range of 13mm. When replacing a conventional head, the fine-pitch type can use the common range in the middle of the spindle travel. The standard and compact types of fine-pitch head are completely interchangeable.

Fine Pitch (Pitch = 0.1mm)

Standard Type

Suitable for most applications

- Spindle: SKS3 H steel (hardness HRC60 or more), lapped tip
- Scale: Satin-chrome plated
- Recommended mounting thickness for locknut-type stem: 6mm

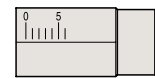
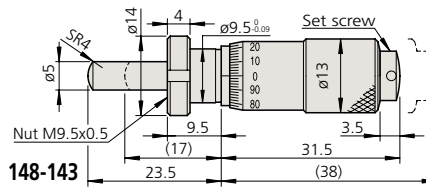
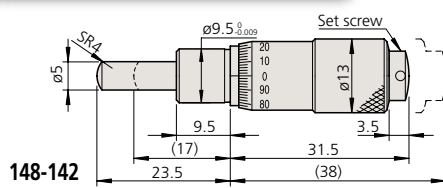

Sleeve marker

Order No.	Measuring range	Spindle pitch	Graduations	Stem type	Tip shape	Scale spec	Accuracy	Mass
148-142	0 - 6.5mm	0.1mm	0.002mm	Plain	Spherical (SR4mm)	Normal graduations	±2µm	31g
148-143				Locknut				34g

Fine Pitch (Pitch = 0.1mm)

Compact Type

Thicker and shorter thimble reduces length

- Spindle: SKS3 H steel (hardness HRC60 or more), lapped tip
- Scale: Satin-chrome plated
- Recommended mounting thickness for locknut-type stem: 6mm

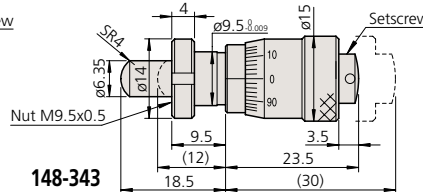
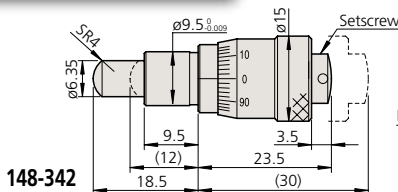

Sleeve marker

Order No.	Measuring range	Spindle pitch	Graduations	Stem type	Tip shape	Scale spec	Accuracy	Mass
148-342	0 - 6.5mm	0.1mm	0.002mm	Plain	Spherical (SR4mm)	Normal graduations	±2µm	29g
148-343				Locknut				31g

Fine Pitch (Pitch = 0.1mm)

Small, Light Type

Small diameter, space-saving design

- Spindle: SKS3 H steel (hardness HRC60 or more), lapped tip
- Scale: Satin-chrome plated
- Recommended mounting thickness for locknut-type stem: 4mm

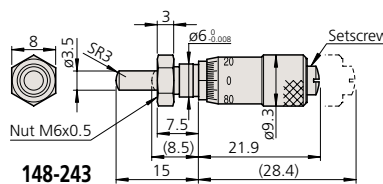
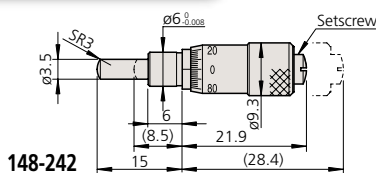

Sleeve marker

Order No.	Measuring range	Spindle pitch	Graduations	Stem type	Tip shape	Scale spec	Accuracy	Mass
148-242	0 - 6.5mm	0.1mm	0.002mm	Plain	Spherical (SR3mm)	Normal graduations	±5µm	10g
148-243				Locknut				10g

Thimble Torque versus Measuring Force

The thimble rotation torque versus measuring force is practically identical to that of the conventional type of micrometer head, therefore you can manipulate the fine-pitch head with the same degree of 'feel' as before.

Thimble rotation torque with respect to measuring force on spindle

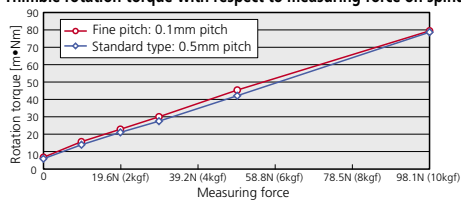

Load Bearing Capacity

(Mitutoyo Experimental Values)

- As a general guide a fine-pitch micrometer head will meet its specified accuracy, operating against a measuring force of 20N, for at least 100,000 rotations by hand.
- The level of static load, in the axial direction, which a mounted micrometer head can withstand before damage or dislocation occurs is shown below for each mounting method. (Maintaining accuracy is not taken into account.)

1. Nut clamp method

Damage to the head will occur at 8.6 to 9.8kN (880 to 1000kgf).

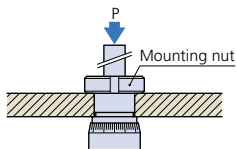

2. Slit clamp method

The head will be pushed out of the bracket at 0.69 to 0.98kN (60 to 100kgf).

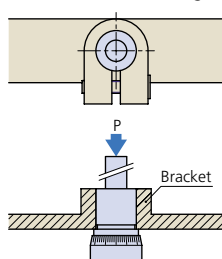

3. Setscrew clamp method

Damage to the head will occur at 0.69 to 1.08kN (70 to 110kgf).

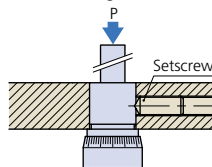

A micrometer head with a screw thread pitch of 0.25mm is also available.

Coordinate Measuring Machines

Vision Measuring Systems

Surface, Form and Contour Measurement

Optical Measuring

Sensor Systems

Hardness Measuring

Digital Scale and DRO Systems

Small Tool Instruments and Data Management

Mitutoyo Scandinavia AB

Släntv. 6 • Box 712

SE-194 27 Upplands Väsby

Tel: 08-594 109 50

Fax: 08-590 924 10

info@mitutoyo.se

www.mitutoyo.se

Note: All information regarding our products, and in particular the illustrations, drawings, dimensional and performance data contained in this pamphlet, as well as other technical data are to be regarded as approximate average values. We therefore reserve the right to make changes to the corresponding designs, dimensions and weights. The stated standards, similar technical regulations, descriptions and illustrations of the products were valid at the time of printing. In addition, the latest applicable version of our General Trading Conditions will apply. Only quotations submitted by ourselves may be regarded as definitive.

Mitutoyo